

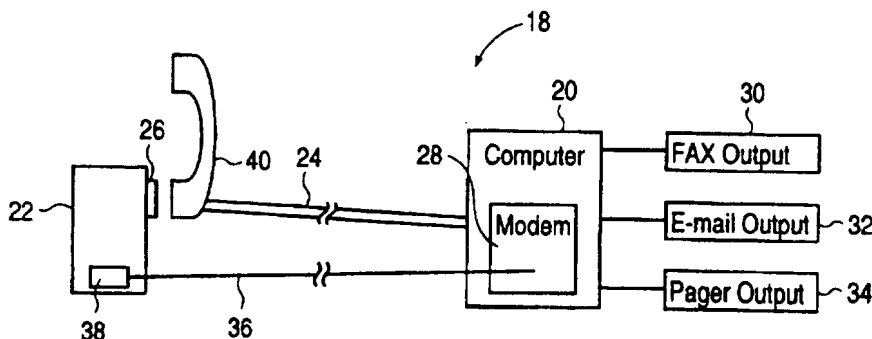

INTERNATIONAL APPLICATION PUBLISHED UNDER THE PATENT COOPERATION TREATY (PCT)

<p>(51) International Patent Classification ⁶ : H03M 13/00, H04L 1/18, H04M 11/00</p>	<p>A1</p>	<p>(11) International Publication Number: WO 97/26709 (43) International Publication Date: 24 July 1997 (24.07.97)</p>
<p>(21) International Application Number: PCT/US97/00823 (22) International Filing Date: 16 January 1997 (16.01.97) (30) Priority Data: 08/588,165 18 January 1996 (18.01.96) US (71) Applicant: POCKETSCIENCE, INC. [US/US]; P.O. Box 391143, Mountain View, CA 94039 (US). (72) Inventors: FULLAM, Scott, F.; 2149 Junction Avenue #12, Mountain View, CA 94043 (US). PERETZ, Neil, M.; P.O. Box 391143, Mountain View, CA 94039 (US). (74) Agent: LOHSE, Timothy, W.; Gray Cary Ware & Freidenrich, 400 Hamilton Avenue, Palo Alto, CA 94301-1825 (US).</p>	<p>(81) Designated States: AL, AM, AT, AU, AZ, BA, BB, BG, BR, BY, CA, CH, CN, CU, CZ, DE, DK, EE, ES, FI, GB, GE, HU, IL, IS, JP, KE, KG, KP, KR, KZ, LC, LK, LR, LS, LT, LU, LV, MD, MG, MK, MN, MW, MX, NO, NZ, PL, PT, RO, RU, SD, SE, SG, SI, SK, TJ, TM, TR, TT, UA, UG, UZ, VN, ARIPO patent (KE, LS, MW, SD, SZ, UG), Eurasian patent (AM, AZ, BY, KG, KZ, MD, RU, TJ, TM), European patent (AT, BE, CH, DE, DK, ES, FI, FR, GB, GR, IE, IT, LU, MC, NL, PT, SE), OAPI patent (BF, BJ, CF, CG, CI, CM, GA, GN, ML, MR, NE, SN, TD, TG).</p> <p>Published <i>With international search report.</i></p>	

(54) Title: ELECTRONIC MESSAGING SYSTEM AND METHOD



(57) Abstract

A multi-function electronic messaging system (18) for transmitting messages over a first communications link (24) having a remote unit (22) for generating forward error corrected signals representing various types of electronic messages, for generating acoustical tones corresponding to the error corrected signals is provided. The acoustical tones are coupled to the send-only first communications link (24) and transferred to a computer (20). The computer sends an acknowledgement signal back to the user of the remote unit (22) over the first communications link (24) and decodes and error checks the signals. The computer (20) also reformats the various messages and resends them out over various communication links depending on the ultimate destination of the message. The computer (20) may also send messages to the remote unit (22) over a receive-only second communications link (36).

FOR THE PURPOSES OF INFORMATION ONLY

Codes used to identify States party to the PCT on the front pages of pamphlets publishing international applications under the PCT.

AM	Armenia	GB	United Kingdom	MW	Malawi
AT	Austria	GE	Georgia	MX	Mexico
AU	Australia	GN	Guinea	NE	Niger
BB	Barbados	GR	Greece	NL	Netherlands
BE	Belgium	HU	Hungary	NO	Norway
BF	Burkina Faso	IE	Ireland	NZ	New Zealand
BG	Bulgaria	IT	Italy	PL	Poland
BJ	Benin	JP	Japan	PT	Portugal
BR	Brazil	KE	Kenya	RO	Romania
BY	Belarus	KG	Kyrgystan	RU	Russian Federation
CA	Canada	KP	Democratic People's Republic of Korea	SD	Sudan
CF	Central African Republic	KR	Republic of Korea	SE	Sweden
CG	Congo	KZ	Kazakhstan	SG	Singapore
CH	Switzerland	LI	Liechtenstein	SI	Slovenia
CI	Côte d'Ivoire	LK	Sri Lanka	SK	Slovakia
CM	Cameroon	LR	Liberia	SN	Senegal
CN	China	LT	Lithuania	SZ	Swaziland
CS	Czechoslovakia	LU	Luxembourg	TD	Chad
CZ	Czech Republic	LV	Latvia	TG	Togo
DE	Germany	MC	Monaco	TJ	Tajikistan
DK	Denmark	MD	Republic of Moldova	TT	Trinidad and Tobago
EE	Estonia	MG	Madagascar	UA	Ukraine
ES	Spain	ML	Mali	UG	Uganda
FI	Finland	MN	Mongolia	US	United States of America
FR	France	MR	Mauritania	UZ	Uzbekistan
GA	Gabon			VN	Viet Nam

ELECTRONIC MESSAGING SYSTEM AND METHODBACKGROUND OF THE INVENTION

5 The present invention relates generally to an electronic messaging system, and more particularly to an inexpensive, portable electronic messaging system and method that allows transmission of facsimile, electronic mail and pager messages over a first communications link, as well as reception of incoming messages over a second communications link.

10 Prior to the proliferation of computers, people communicated store-and-forward style messages (i.e., messages that are first stored in some manner and then later forwarded) using facsimile machines and direct computer-to-computer data connections over existing and leased telephone lines. As computers became cheaper and easier to use, people began using more advanced facsimile machines, computer facsimile modems, and direct computer-to-computer modem connections to transfer information between each other.

15 More recently, people began to use commercial on-line services to communicate large amounts of store-and-forward style information (i.e., electronic mail) with each other. Now, a new medium for communicating, the Internet, is attaining general public popularity. In the last five years, the number of people connected to the Internet has increased because the Internet allows users who have an Internet account, a modem, and a computer to communicate great amounts of information with each other, regardless of each party's method of accessing the Internet or the geographic location of their Internet access point, at minimal expense. For example, for the cost of a local telephone call, a person in California can send a long electronic mail (e-mail) message to a friend (who also must have Internet access) anywhere in the world. Due in large part to the Internet, the popularity of electronic store-and-forward messaging, such as e-mail,

SUBSTITUTE SHEET (RULE 26)

has also increased exponentially.

Initially, due to the large size of computers, people typically only accessed the Internet from a desktop computer. Later, as the size of computers decreased from desktops to notebooks to palmtops, people could carry their computer with them wherever they go and access their e-mail account from any location where they could locate a telephone jack to connect, via modem, to the Internet.

At the same time that e-mail was increasing in popularity, paging technology was also increasing in popularity. Many people carry pagers to ensure that others can easily reach them at any time. In addition, a new product category of portable computer, known as a personal digital assistant (PDA) was introduced. The PDAs are basically very small handheld computers (several of which offer limited messaging capabilities, such as paging or e-mail), but are priced too high (i.e., in excess of \$500) for purchase by the average consumer and do not offer communication features well-tailored to the average consumer user's needs.

Today, a number of PDAs are on the market. One well-known PDA has a small touch-sensitive screen controlled by special user-interface software. This PDA also has a modem that allows a user to communicate with a computer network and to send e-mail messages, facsimiles, and pager messages. This PDA and its accessories, however, are very expensive, and require that the user locate a phone jack for message transmission and reception. In these well known current PDA systems on the market today, all messages are transmitted and received over the same communications link, which requires an expensive modem and extensive handshaking time between the modem in the PDA and the modem to which the PDA is connected.

A second well known PDA is a cellular telephone with a touch-sensitive backlit display that acts as a keyboard. This second PDA has the ability to send facsimiles, to communicate with commercial on-line services, and to manage a user's schedule with a built-in time management system. This second PDA, however, is also very expensive and too large and heavy to carry around in a

SUBSTITUTE SHEET (RULE 26)

user's pocket. In addition, due to this PDA's circuit-switched communications, costs can be very high because it can only communicate over more expensive cellular telephone systems, rather than using less expensive landline telephones and short-burst packet data transmission protocol. In addition, because this PDA
5 relies solely on cellular communications, it has relatively high power consumption, which leads to a very short battery life.

All of the known messaging systems that allow a user to both send and receive multiple types of electronic messages (i.e., facsimile, pager and e-mail) are too large, too expensive, too inconvenient (i.e., they require telephone connectivity
10 through an RJ-11 telephone jack) or drain a battery too quickly. In addition, these known systems cannot send a message reliably over a normal public pay telephone line or many cellular links due to occasional line noise problems that cannot be corrected by known systems, and due to a lack of more convenient (i.e. appropriate acoustic) telephony coupling technology. In addition, none of these
15 known systems provide an inexpensive way to send different types of messages and also provide the user with an audible acknowledgement signal from the receiving computer indicating whether or not the message is sent correctly.

Thus, there is a need for an electronic messaging system that is inexpensive and transmits various types of electronic messages over any type of
20 communications link. There is also a need for an electronic messaging system that has a system for sending an audible acknowledgement signal back to the user and a system for performing multiple levels of error detection and correction. The electronic messaging system in accordance with the invention addresses the above problems of conventional messaging systems and it is to this end that the invention
25 is directed.

SUMMARY OF THE INVENTION

The invention provides an inexpensive, portable electronic messaging system and method that may be easily coupled to a communications link, such as
30 a pay telephone handset. It may send any type of electronic messages over a first

communications link. The electronic messaging system also receives incoming messages over a second communications link that is separate from the first communications link.

5 The electronic messaging system may also send electronic mail, facsimiles, and paging messages over the same first communications link, through a computer; and allow a user to receive immediate audible feedback, (i.e., a signal acknowledging the receipt of the transmitted data) over the first communications link from the computer.

10 The electronic messaging system of the invention also may have a forward error correction scheme that increases the reliability of message transmission over a noisy communications link. The error correction scheme may include multiple levels of error detection and correction to further increase the message transmission reliability. The error correction levels may include data packet level error correction, resending corrupt data packets in response to a corrupt data
15 packet acknowledgement signal from a central computer, and bit level error correction.

The electronic messaging system and method of the invention may employ a computer and a unit remote to the computer for communicating data between the computer and the remote unit. The remote unit may have a system for
20 receiving input from a user and for producing electrical signals corresponding to the input data. The remote unit may also have a system for producing error corrected data based on the electrical signals and for producing acoustical tones corresponding to the error corrected data. The remote unit may also have a system for coupling the acoustical tones to a first communications link for
25 transmission to the computer.

The computer may have a system for detecting and correcting errors in the data represented by the acoustical tones and a system for sending a signal back to the user of the remote unit over the first communications link to acknowledge receipt of the acoustical tones. The remote unit, in addition, may have a system for

receiving data from the computer over a second communications link.

The electronic messaging system also may have a method of error detecting and correcting data in the computer that includes checking data packets for errors, resending any data in which any data packets contain any errors, comparing the data packets to the resent data packets, and comparing each bit in the data packets to each bit in the resent data packets to determine a correct bit. The method may generate an integrity flag, for each data packet, that indicates errors within each data packet.

BRIEF DESCRIPTION OF THE DRAWINGS

Figure 1 is a schematic diagram of an embodiment of the electronic messaging system of the present invention including a computer and a unit remote to the computer for communicating electronic messages between the computer and the remote unit;

Figure 2 is a block diagram of an electronic messaging system in accordance with the invention that has a plurality of remote units communicating with the computer;

Figure 3 is a front view of the remote unit shown in Figure 1;

Figure 4 is a side view of the remote unit shown in Figure 1;

Figure 5 is a back view of the remote unit shown in Figure 1;

Figure 6 is a top view of the remote unit shown in Figure 1;

Figure 7 is a more detailed block diagram of the remote unit shown in Figures 3-6;

Figure 8 is a more detailed block diagram of the telecommunications interface that sends incoming messages to the computer of Figure 1;

Figure 9 is a flowchart showing a method of processing an incoming message from a remote unit that may be carried out by the incoming message system within the computer;

Figure 10 is a schematic diagram showing the electronic messaging communications transfer protocol;

Figure 11 is a flowchart of a method of multiple error detection and

correction of the invention that may be carried out by the incoming message system;

Figure 12 is a schematic diagram of the error packet overlay error correction method that is part of error correction method shown in Figure 11;

5 Figure 13 is a flowchart of the error packet overlay error correction method shown in Figure 12; and

Figure 14 is a schematic diagram of the majority bit voting packet error correction method, shown in Figure 11.

DETAILED DESCRIPTION OF THE PREFERRED EMBODIMENTS

10 The present invention is generally applicable to an electronic messaging system that can transmit electronic messages, such as facsimile messages, pager messages, and e-mail messages. The electronic messaging system in accordance with the invention will be described in that context. It will be appreciated, however, that the system and method of the invention has greater utility.

15 The multi-function electronic messaging system in accordance with the invention may include a computer, and a hand-held, portable, battery powered unit. The unit is located remotely from the computer and generates and transmits electronic messages, such as pager, facsimile, and e-mail messages, over a first communications link to the computer, and receives incoming messages from the
20 computer over a second communications link. The remote unit may also have a display device and an input device for creating and viewing messages. The remote unit may also have a coupling system so that signals from the remote unit may be coupled to and transmitted through the first communications link. The computer of the electronic messaging system may receive the incoming remote
25 unit electronic messages, may detect and correct errors in remote unit signals, and may transmit an audible signal back to the user of the remote unit, over the first communications link, indicating receipt of the remote unit signals. The computer may also transmit the various types of electronic messages from the remote unit

(i.e., e-mail, pager, and facsimile) over various appropriate outputs, and transmits messages back to the remote unit over a second communications link.

Figure 1 is a schematic diagram of an electronic multi-function messaging system 18 embodying the invention. As shown, the electronic messaging system 18 may include a computer 20, and a portable unit 22 remote to the computer. A first communications link 24, such as an ordinary telephone line, may connect the remote unit 22 to the computer 20 to permit the transmission of messages from the remote unit to the computer. The remote unit preferably generates acoustic tone patterns (V.23 CCITT originating station modem tone frequencies to indicate a serial 1/0 bit stream) representing various types of electronic messages created by a user. The acoustic tones may be output by an output device 26, such as a speaker, and transmitted over the first communications link to the computer, which interprets the tones from the remote unit using a data receiver modem 28, that is described below in more detail. The computer may detect and correct errors in the data, as described below, sent to it by the remote unit, and may generate an audible signal that is sent back to the user of the remote unit over the first communications link. The signal may indicate a sufficiently error-free data transmission or may indicate that the data must be resent because the transmission is not sufficiently error-free.

The computer may also separate out the individual types of messages according to their ultimate destination (i.e., facsimile, e-mail, and pager messages), and send those messages to the appropriate sub-system within the computer that transmits the messages (i.e., a facsimile machine sub-system for transmission of facsimile messages). In the system shown in Figure 1, the computer may have a facsimile output 30, an e-mail output 32 and a pager output 34. The multi-function electronic messaging system according to the present invention may process any other type of electronic messages and may also have additional types of functions, such as a voice messaging system. The computer may also send incoming electronic messages to the remote unit over a second communications link 36, as will be described below.

The separation of the first communication link for transmitting data from the second communications link for receiving data provides many advantages. In particular, the first communications link is used solely for unidirectional transmission of messages from the remote unit (i.e., send-only, with no handshaking between the computer and the remote unit), in packet form, and the second communications link is used solely for unidirectional transmission of messages from the computer to the remote unit (i.e., receive-only, with no handshaking between the computer and the remote unit), in packet form as well. This unidirectional transmission of packetized messages is faster than traditional bi-directional transmission because the bi-directional transmission requires handshaking and greater synchronization between the remote unit and the computer. The unidirectional transmission also may maximize the use of the most convenient communications link for time-sensitive messages from the computer to the remote unit, and may use more affordable bandwidth for the transmission of messages from the remote unit to the computer.

In this embodiment, the second communications link may be a wireless pager frequency link. To receive the incoming pager messages, the remote unit may have a pager receiver 38. In addition, the first communications link may be a pay telephone line with a receiver handset 40, and the remote unit speaker is held against the telephone handset microphone to couple the acoustical tones to the telephone line. The first and second communications links may be any type of communications link, and are not limited to the examples shown in Figure 1.

Figure 2 is a block diagram of the computer 20 connected to a plurality of remote units 50, 52, 54, 56 and 57. The remote units may be connected to the computer, as shown, through a variety of different first communication links, such as a public telephone line 58, an office public broadcast exchange (PBX) 60, a hotel telephone switchboard and branch exchange 62, an ISDN link 64, or a cellular telephone link 66 through a cellular base station 68. In addition, as described above, the remote units may also have a built-in or external pager radio receiver (not shown), so that the remote units can receive incoming pager messages over the second communications link, such as radio pager system 70.

All of the remote units attached to the different first communications links, are connected to the computer by a Public Switched Telephone Network (PSTN) 72 that may handle a plurality of telephone calls from remote units by switching the calls to various incoming telephone lines and a plurality of modems (not shown) in the computer. The modems are connected to a telecommunications interface 74 sub-system of the computer that interprets and translates (converts) the incoming acoustical tones from the remote units into electronic digital form. The telecommunications interface then forwards the interpreted incoming remote unit data to an incoming message System 76 that processes the incoming data from the remote units, and detection and correction of errors is performed in an error detection and correction system 78, and routes the messages to the appropriate outgoing systems, as described below. The operation of the incoming message system will be described below with reference to Figure 9. All of the computer systems may include microprocessors or multi-tasking computer servers and are connected together by a backbone network 80, such as an Ethernet network, so that all of the systems within the computer may exchange data with each other. In this embodiment, the outgoing systems shown are an outgoing facsimile system 82, an e-mail system 84, a pager system 86, a billing, message and user profile system 88, and a backup system 90. The invention is not limited to the outgoing systems shown and may have other systems, such as a voicemail system.

If some of the data received by the incoming message system 76 is a facsimile message, then the message is first error detected and corrected in the error detection and correction unit 78 and then routed over the backbone network to the outgoing facsimile system 82, that may have a facsimile machine 92 or server attached to it for sending outgoing facsimile messages. If some of the data received by the incoming message system is an outgoing electronic mail (e-mail) message, the message is routed to the e-mail system 84, and then over an electronic mail channel, such as the Internet. For an incoming e-mail message to the remote unit user, the e-mail message is received by the e-mail system and routed to the pager system 86, which sends the message to the remote unit through a paging terminal and transmitter 70 in the form of a pager message. If some of the data received by the incoming message system is an outgoing pager

SUBSTITUTE SHEET (RULE 26)

message, then the message is routed to the pager system 86 that is connected to the paging terminal and transmitter 70.

5 The billing, message and user profile system 88 stores all of the information necessary to keep track of billing, message usage, and user profiles. The billing, message and user profile system may also have a database 94 and an archival storage device 96, for short term and long term storage, respectively, of the user profiles and billing information. The database also stores audible messages (i.e., prerecorded voice messages) that may be sent to the user of the remote unit user over the first communications link (i.e., as an acknowledgement that data from the remote unit has been properly received). The back-up system 90 may include a back-up facsimile system, a back-up e-mail system, a back-up pager system, a back-up incoming Message system and a back-up billing, message and user profile system that are all connected together by a back-up network. The details of the back-up system are not shown. This back-up system provides redundancy within the computer to reduce lost data due to crashes and other possible malfunctions and mishaps.

10 Figures 3, 4, 5 and 6 show a front, side, back and top views, respectively, of a preferred implementation of the remote unit 22. It may include a display device 100, such as a liquid crystal display (LCD), and a user input device 102, such as a keyboard. The input device receives information from the user, such as text messages, and later generates electrical signals corresponding to those electronic messages. The display device displays any electronic messages created by the user and displays any incoming messages. The display device also displays the address book, the calendar, and any other programs that are resident in the remote unit memory. To initiate the transfer of data from the remote unit to the computer, the remote unit may have a send button 104. On the back side of the remote unit, as shown in Figure 5, there may be a battery compartment 106 and the sound output device 26, such as a speaker. The sound output device outputs modulated data tones (V.23 outgoing compatible tones) generated by a one-way acoustic data modulator (not shown) inside the remote unit. The sound output device permits the remote unit to communicate to the computer by coupling

the acoustical tones to the first communications link, such as an ordinary telephone line as shown in Figure 1. On the end of the remote unit, as shown in Figure 4, is an interface port 108 so that a user can transfer data, such as e-mail addresses, calendar appointment records and saved e-mail messages, between the remote unit and a personal computer. As shown, the remote unit may be a small, handheld, pocket-sized, battery powered messaging system.

Figure 7 is a detailed block diagram of the remote unit 22, that may include the input device 102 that have a plurality of keys including the SEND key 104, as described above. The remote unit may also have a central processing unit (CPU) 120 that controls the operations of the remote unit, may generate forward error corrected data based on the electrical signals generated by the input device, and may generate acoustical tones for communicating the forward error corrected data to the computer. The CPU may also generate the acoustical tones from the electrical signals if no error correction is conducted on the electrical signals. The remote unit may also have an external memory unit 122 for storing data and software programs that run within the CPU, the display device 100 for displaying messages, an incoming message receiver 124, such as a pager system for receiving incoming messages from the computer, and a coupling system 126 for coupling the acoustical tones generated by the CPU to the first communications link (not shown). The memory unit may store an address book program, address book data, a calendar program, calendar appointment records, stored outgoing message data, an encryption system, an error correction system, and a plurality of incoming messages.

The CPU 120 may have a plurality of interfaces (not shown) that connect various input and output devices to the CPU, such as the input device 102, a power switch 128, a real-time clock 130, the display device 100, a PC interface system 132, the incoming message receiver 124, the external memory unit 122, and a user alert system 134. The external memory unit may include a ROM 136, an SRAM 138, and an EEPROM 140. The ROM may store various program code, including the software for generating the DTMF acoustical tones and the modulated data tones. The SRAM may store incoming and outgoing messages. The

combination of a special battery switching circuit (not shown) and the SRAM means that the SRAM memory contents (incoming and outgoing message data) is not lost when the power is shut off to the remote unit. The EEPROM may store various data, such as a remote unit identification number, any e-mail screening
5 criteria (described below), any encryption key, and any other configuration data.

The power switch 128 turns the remote unit on and off. The real-time clock 130 dates and time stamps all the outgoing messages, and provides a real time clock to the user. The display device 100 may also have an LCD driver 142 that controls the output device, and a light emitting diode (LED) 144 for backlighting the
10 output device to allow viewing of the output device under low light conditions.

The outgoing and incoming messaging systems within the remote unit will now be described. The incoming messages may be received over the second communications link, such as pager frequencies, by the incoming message receiver 124 that may include a pager antennae 146, a pager receiver 148, and a
15 pager protocol decoder 150. If a different type of second communications link is used, such as a wireless link, then another type of incoming message receiver may be used.

The outgoing messages of the remote unit may be coupled to the first communications link. For outgoing messages, a program stored in the ROM may
20 generate electrical signal corresponding to messages input by a user with the input device. As described above, error corrected signals may also be generated by the CPU, depending on the type of error correction is selected by the user. Then, a software based tone generator, stored in the ROM, generates acoustical tones corresponding to the electrical signals or the error corrected electrical signals.
25 Once the acoustical tones are produced, the tones are sent to the coupling system 126 where the tones are converted to a digital signal by a digital-to-analog converter 152, amplified by an audio amplifier 154, and output by the speaker 26. The acoustical tones, generated by the speaker, as described above, may be
30 coupled to a first communications link 24 by, for example, holding the speaker near the pay telephone handset microphone 40, as shown in Figure 1.

The remote unit may also have the PC interface system 132 that may include an RS232 interface 156 that sends data from the remote unit over an RS232 port (not shown) to a personal computer (not shown) and receives data from a personal computer over the RS232 port and converts that data into remote unit compatible data. The user alert system 134 may include a vibrating buzzer 158, a piezoelectric beeper 160, and an LED 162. All of these devices are used to notify the user of the remote unit of various conditions. For example, the vibrator may vibrate to notify the user that an incoming message has been received. Similarly, the buzzer and the LED may also be used to notify the user.

The operation of the electronic messaging system for generation and transmission of messages from the remote unit to the computer will now be briefly described. Once a remote unit user has entered a message into the remote unit using the input device, such as a keyboard or touch sensitive screen, the user indicates how the message is going to be sent (i.e., by facsimile, e-mail or pager). The user may also enter multiple messages to be ultimately sent through a variety of transmission methods and mediums. The user may also view the messages that he is creating using the output device. Once all of the messages have been entered and stored, the CPU of the remote unit generates electrical signals corresponding to the electronic messages of the user and also, if the option is selected, the remote unit produces forward error corrected signals corresponding to the electrical signals. Then, the user can go to a first communications link, such as a pay phone or any other communications link, such as cellular telephone, and dial an access number that connects the user to the computer.

Once the user connects to the computer, the computer will request, via an audible message (i.e., a prerecorded voice message), that the user place the remote unit speaker against the telephone handset microphone, and initiate the message transfer from the remote unit to the computer. When the user depresses the SEND button, the CPU and software based tone generator generate acoustical tones corresponding to either the electrical signals or the forward error corrected electrical signals. The remote unit couples the acoustical tones to the first communications link using the speaker and the messages, in the form of electrical

SUBSTITUTE SHEET (RULE 26)

signals, are transferred to the computer. The messages that are sent by the remote unit to the computer may be encrypted for security or compressed to decrease the sending time. The messages may also be forward error corrected, as described above.

5 Once the message transfer is complete, the computer, using an error correction and detection method that will be described below, tests the message to determine if the message is sufficiently error-free. In the computer determines that the messages are sufficiently error-free, the computer then audibly notifies the user, using a synthesized or pre-recorded voice message or a tone, that the transfer of
10 messages was successful. If the computer determines that the message contains too many errors, the computer will play a different audible message through the first communications link to tell the user to resend the message. The details of the messaging transfer protocol, and the error correction method will be described in more detail below.

15 Figure 8 is a detailed block diagram of the telecommunications interface 74 that is part of the data receiver modem 28, shown in Figure 1. The modem may include a modem CPU 180, a memory unit 182, a message transceiver 184, and an incoming message system interface 186. The modem CPU may have a first UART port 188 that communicates with the incoming message system interface, such as
20 an RS232 level shifter 190 to communicate data back and forth between the incoming remote unit server and the data receiver modem. A second UART port 192 in the CPU connects to the message transceiver for receiving remote unit data (acoustical tones) and transmitting a signal acknowledging receipt of the remote unit data back to the user of the remote unit over the first communications link.

25 The memory unit 182 may have a RAM 194 that may act as a buffer for the incoming electronic messages and may temporarily store program information and variables, such as the set-up information for each particular remote unit. The memory unit may also have a ROM 196 for storing software programs that run on the modem CPU. The incoming data from the remote unit and outgoing

acknowledgement signals to the user of the remote unit go through the message transceiver that may include a telecommunications interface 197, a first and second amplifier 198, 200, and a data demodulator 202. The incoming data from the remote unit may be carried over the first communications link (not shown) to
5 another communications network, such as a Public Switched Telephone Network (PSTN) 204, or the first communications link itself may be the PSTN. The incoming tones are converted to electrical signals by the telecommunications interface, amplified by the first amplifier, demodulated by the data demodulator, and enter the modem CPU through the UART port. For outgoing acknowledgement signals
10 sent out over the PSTN and any other first communications link, the modem CPU signals another sub-system (not shown) within the computer to generate a signal, such as a synthesized or pre-recorded audio message. The modem CPU also controls this signal by controlling the enabling signal to the second amplifier 200. Thus, the signal is fed into the second amplifier, through the telecommunications
15 interface, and transmitted over the PSTN 204 or any other first communications link back to the user of the remote unit. The telecommunication interface 197 is controlled by an ON/OFF hook signal (the phone line is switched between on and off hook conditions) generated by the modem CPU. An incoming ring condition from the PSTN generates a ring detect signal that is fed into the modem CPU,
20 causing the modem CPU to activate the telecommunications interface.

Fig. 9 is a flowchart showing the operation taken by the incoming message system 76, shown in Figure 2, for processing an incoming remote unit message. At 220, the telephone call from the user with the remote unit is answered by the incoming message system and, at 222, the incoming message system plays an
25 audible message, such as a synthesized or pre-recorded voice message, instructing the user to "Send the data now" by holding the remote unit next to the telephone handset microphone and pressing the Send button. The voice message played by the incoming message system may be stored in the database, shown in Fig. 2. Then at step 224, the incoming message system receives data from the
30 remote unit, including any outgoing message data, any new e-mail screening criteria, and a log of pager messages received by the remote unit since last communication with the incoming message system.

SUBSTITUTE SHEET (RULE 26)

The e-mail screening criteria allow the computer to automatically screen e-mail messages ultimately destined for the remote unit user. For example, messages that are sent from a person considered particularly annoying by the user of the remote unit may be screened out. The pager message log is used to
5 ensure that the remote unit user receives all of his/her incoming pager messages and to cause the computer to retransmit any lost pager messages. After the error correction and detection is performed at 225, at 226, it is determined whether or not all of the data received from the remote unit is sufficiently error-free. The error detection and correction that occurs in the incoming message system when a
10 message is received will be described in more detail below with reference to Figure 11 - 14. If the data contains too many errors, then control goes back to 222, where the incoming message system plays an audible message requesting that the data be resent. However, if the data is sufficiently error-free, then at 228, the incoming message system plays another audible message that tells the user that
15 the data was received clearly. The messages played by the incoming message system may be stored in the database, shown in Figure 2. After the data received message is played, the incoming message system hangs up the phone at 230.

After hanging-up the phone with the user, the further processing of the incoming data stream begins (232). The incoming data is separated into the e-mail
20 screening criteria, as described above, the incoming messages (each being separated according to its ultimate destination), and the log of previously received pager messages, as described above. Then, the log of previously sent pager messages is analyzed (234) and compared to the log of previously received pager messages, and it is determined if all paging messages sent to the user's remote
25 unit were properly received since the user last uploaded data to the incoming message system (236). If the user's remote unit has not properly received all of the previously sent pager messages, then the incoming message system locates the user's missing/lost pager messages in the database (238), shown in Figure 2, and uploads them to the paging system, shown in Figure 2, for re-transmission to
30 the remote unit.

Once any missed pager messages have been re-transmitted, or once all

previously sent pager messages have been confirmed as received, then the incoming message system at 240, forwards any changes in the e-mail screening criteria to a user records database stored in the database, shown in Figure 2. Then, at 242, any outgoing messages are forwarded to an outgoing message stack and control in the computer is now transferred, at 244, to the individual systems that handle the various types of outgoing messages. For example, if the outgoing messages contained an e-mail message and a facsimile message, then control would go to the facsimile system and to the e-mail system. The various message systems in the computer may also operate simultaneously and independently and process several different messages simultaneously.

Figure 10 is a schematic diagram showing the transfer communications protocol between the remote unit and the computer during data transfer. The transfer protocol provides a way of identifying the remote unit to the computer, a method of verifying that the data has been received correctly, and a way of requesting that the data be resent if it is received unclearly. As shown, there may be six phases of a data transfer between the remote unit and the computer, including a dial phase 260, a connect phase 262, a preamble transmission phase 264, a data transmission phase 266, an acknowledgement phase 268, and an end phase 270.

In the dial phase 260 and connect phase 262, a connection through a first communication link, such as a telephone line, is established between the user of the remote unit and the computer. The computer may generate an audio tone, or synthesized voice welcome message instructing the user to begin sending data. Once connected, the user holds the speaker of the remote unit close to the telephone handset microphone and presses the SEND button of the remote unit to initiate the preamble phase of the communications protocol between the remote unit and the computer.

In the preamble phase 264, the remote unit sends preamble data to the computer. The preamble data may include a synchronization part, a remote unit identification number, features data, a time and date stamp, error correction type

data, modulation selection data, packet size selection data, a checksum, and extension data for any additional information. The features data notify the computer of the particular features of the particular remote unit in use at that time, such as the type of acknowledgement signal, whether a cellular phone connection is being used, whether the data is encrypted, and whether the acknowledgement from the computer to the remote unit user should occur at the end of each data packet transmission or at the end of all data packet transmissions (i.e., after the entire datastream containing the plurality of data packets has been transmitted). The preferred acknowledgement signal may be generated after the entire datastream has been transferred, as described above. The error correction data specifies the type of forward error correction being used for the data transmission. The packet size data permits the size of the data packets (i.e., the number of bytes between acknowledgement signals) to be varied between 1 byte and 256 bytes. The checksum data is transmitted in the preamble to enable the computer verify the integrity of the data in the preamble.

The remote unit may also permit the user to select one of several transfer modes before the data is transferred from the remote unit to the computer. The changes in the user selectable transfer mode may effect changes in the values of the data sent within the preamble, including the type of forward error correction being used, the type of modulation being used, and the number of times that data will be resent. The user selectable transfer mode may allow the user to choose between a cellular mode, a payphone mode (a payphone typically has more noise problems than a normal telephone line), and a normal telephone line mode. Each of these user selectable modes configures the transfer protocol differently to optimize the remote unit's transmission for each particular environment. For example, for a cellular connection, which is generally extremely noisy and hard to communicate over, the amount of forward error correction may be increased, the modulation may be changed, and the number of times data may be resent is increased. Thus, a user is able to select a transfer protocol that is optimized for a particular type of first communications link, and the remote unit may provide data formatted in that optimized transfer protocol to the computer.

Once the preamble is received and the computer has configured itself to receive data formatted in accordance with the user selectable transfer protocol, the remote unit transfers the data containing the various electronic messages and forward error corrected electronic messages in the transmit phase 266. Once the transmission of the data is complete, the computer checks all of the data packets within the data for errors, as described below.

In the acknowledgement phase 268, the computer transmits an acknowledgement signal that may either inform the user that the data was received without uncorrectable errors or inform the user that the data must be resent due to errors within the data packets. Once the data has been correctly received, the computer generates a closing message to the user, during the end phase 270, and closes the phone connection with the user and the remote unit.

The transfer protocol provides a system wherein the user of the remote unit may select a different transfer protocol, depending on the communications link to be used, in order to optimize the transfer, as described above. The transfer protocol may also permit the user to receive an audible acknowledgement signal from the computer. This acknowledgement signal enables the user to know that the data has been received without errors or must be resent immediately after the data transmission so the user can resend the data without having to reestablish another connection through the first communications link. A preferred error detection and correction scheme will be described below, but many different error detection and correction schemes, such as a checksum scheme, may be used in the encoding of data to be sent by the remote unit system.

Figure 11 is a flowchart showing the error detection and correction method used in the electronic messaging system of the present invention. The error correction method of the present invention is carried out within the incoming message system 76 shown in Figure 2. The encoding of the datastream (the data uploaded from the remote unit to the computer via the incoming message system and its modems) using the error correction method of the present invention takes place within the remote unit. At 300, the error correction method, that may include

a Bose, Chaughuri, Hocquenghem (BCH) forward error correction system, message resending, and error packet overlay error correction begins. At 302, the incoming message system receives the error correction encoded datastream from the remote unit.

5 The datastream from the remote unit is first encoded by the CPU in the remote unit using a forward error correction method, such as a (15,7,2) BCH information code. With this BCH code, the original data from the remote unit is segmented into seven (7) bits, an extra parity bit is calculated (standard even/odd parity) and concatenated at the end of the fifteen encoded bits to generate a
10 sixteen bit word that is easier for standard computer peripherals to use. The data is sent from the remote unit to the incoming message system sixteen (16) bits at a time. Thus, all data from the remote unit to the incoming message system is sent in sixteen (16) bit packets that include fifteen BCH code bits and one (1) parity bit. The fifteen BCH code bits contain seven (7) actual data bits and eight (8) BCH
15 generated code bits. This BCH code can detect and correct up two (2) random errors within each sixteen bit data packet. In addition, the BCH error correction system can also detect more than two errors per packet, but cannot correct for them. In practice, up to four (4) sequential bit errors in a datastream can be corrected if those errors are equally split between two packets (i.e., if two errors
20 occur at the end of packet N and two errors occur at the beginning of packet N+1).

 At 304, the incoming message system determines if any BCH errors occurred within each packet. If there were no errors within any of the sixteen bit packets sent from the remote unit, then the error correction method is completed
25 at 306. Similarly, if a packet had two or fewer BCH errors, then the BCH error correction method can correct for those errors at 308 and the method is completed at 310. If any data packet had more than two bit errors, the BCH error correction method detects the errors, and the incoming message system will request, through an audible tone or a voice message, that the remote unit user resend the data at
30 312.

After the data is resent at 312, the incoming message system determines if any errors are present within any data packet in step 314. If 0, 1, or 2 errors exist within a data packet of the resent datastream, then the error correction ends at 316. An error packet overlay correction, at 318, may be used, if errors still exist in any of the data packets. The error packet overlay error correction method will be described more fully below with reference to Fig. 12. At 320, it is determined whether any errors still remain after the error packet overlay correction. If all errors have been corrected by the error packet overlay correction, then the method ends at 322. If uncorrectable errors still exist within any data packet after the error packet overlay correction, then in step 324, it is determined whether the data has been sent more than three times. If the data has been sent less than three times, then the process returns to 312 where the data is sent again and error packet overlay correction is conducted. If the data has been sent three or more times, then at 326, a majority bit vote by packet correction method, described in more detail below with reference to Fig. 13, may be invoked. At 328, it is determined whether or not any errors remain after the majority bit vote by packet has been completed. If no errors are present, then the method ends at 330. If errors are still present after the majority bit vote by packet, then the process returns to 312 in which data is resent. In operation, the error correction method of the present invention provides three separate levels of error correction that ensure that an error-free datastream is received by the incoming message system.

Fig. 12 is a schematic diagram showing the error packet overlay error correction method. As a datastream is received by the incoming message system, each 16 bit BCH packet has an integrity flag attached to it by the incoming message system that identifies the packet as a good packet (errors less than or equal to two) or as a bad packet (errors greater than two). If there is at least one bad packet in the datastream, then the entire datastream is resent. As provided above, the datastream may be resent up to N times yielding N datastreams (datastream_1, datastream_2, and so forth, up to datastream_N) that are stored temporarily. As shown, the integrity flags for each packet are also stored along with each individual data packet. A temp_buffer memory 352 is used to store the results of the error packet overlay error correction method set forth in Fig. 13. In

the example shown in Figure 12, for packet A, the packet from datastream_1 is stored in the temporary buffer because it has a good integrity flag. Similarly, for packet A+1, the packet from datastream_2 or datastream_N may be stored in the temporary buffer because both have good integrity flags. For packet A+2, since
5 all of the datastreams have bad integrity flags, the majority bit vote by packet error correction method is conducted. Finally, for packet A+3, any one of the packets from the three datastreams may be used because all of the integrity flags are good.

Fig. 13 is a flowchart showing the operation of the error packet overlay error correction method and when the majority bit voting error correction method is
10 conducted. The method begins at 360. At 362, the integrity flags (flag1, flag2,...flagM) of a particular data packet (1,2,...M) for each datastream are compared to each other. For example, as shown in Fig 12, for data packet A, the integrity flag (flag1) of datastream_1 is good, the integrity flag (flag2) of
15 datastream_2 is bad and the integrity flag (flagM) of datastream_N is bad. At 364, it is determined whether or not all of the integrity flags are good. At 366, if all of the integrity flags for a particular data packet are good, then the data packet with the fewest errors is stored within the temp_buffer memory 352. At 368, it is
20 determined if all of the integrity flags are bad. If all of the integrity flags are bad, then at 370, a majority bit vote by packet is done as long as at least three datastreams are present. If the integrity flags are not all bad, then the packet with the fewest errors is selected at 366.

Figure 14 is a schematic diagram of the majority bit vote by packet method that is part of the error detection and correction method shown in Figure 11. Each
25 bit within the data packet is chosen to match the majority (more than fifty percent) of the bits being compared (i.e., the chosen value is the same as the value of 2 out of 3 bits that are compared). For example, as shown in Fig. 14, bit_one 400 in each datastream is 1,1,..0 respectively for each datastream such that the majority (more than fifty percent) of the bits are equal to "1". Accordingly, bit_one is set to
30 "1". Once the new packet values are determined by the majority bit method, the newly assembled data packets are checked for errors using a conventional

checksum method and the BCH method and are then stored in the temp_buffer memory. In this manner, all of the data packets within the datastream are determined so that the datastream can then be processed by the incoming message system.

5 Thus, using this multi-level error detection and correction system in accordance with the invention, the data transmitted from the remote unit to the computer will be substantially error free. For most transmissions, the data may need only to be resent once and the error packet overlay method will detect and correct any errors in the data. This multi-level error detection and correction
10 system increases message transmission reliability. In addition, this error correction and detection system is fast so that the user will very quickly receive an acknowledgement signal. This quick error detection and correction allows the user and remote unit to stay connected to the computer as short amount of time as possible without sacrificing message transmission integrity.

15 While the foregoing has been with reference to a particular embodiment of the invention, it will be appreciated by those skilled in the art that changes in this embodiment may be made without departing from the principles and spirit of the invention, the scope of which is defined by the appended claims.

WE CLAIM:

1 1. A system for communicating data between a computer and a unit
2 remote from the computer, comprising means in the remote unit for receiving input
3 information from a user and for producing data signals corresponding to the input
4 information; means for producing error corrected message signals from the data
5 signals; means for generating acoustical tones corresponding to the error
6 corrected message signals; means for coupling the acoustical tones to a first
7 communications link for unidirectional transmission to the computer; and a
8 receiving means in the remote unit for unidirectionally receiving data from the
9 computer over a second communications link, which is independent of the first
10 communications link.

1 2. The system of Claim 1, further comprising first receiving means in the
2 remote unit for receiving a signal, over the first communications link, from the
3 computer to the user to acknowledge receipt of the acoustical tones.

1 3. The system of Claim 1, wherein the error corrected message
2 producing means comprises means for generating forward error correction data.

1 4. The system of Claim 1, wherein the remote unit further comprises
2 means for generating facsimile, electronic mail and pager messages.

1 5. The system of Claim 1, wherein the first communications link
2 comprises a telephone link.

1 6. The system of Claim 1, wherein the second communications link
2 comprises a wireless link, and the means for receiving data from the second
3 communications link comprises a radio pager receiver.

1 7. The system of Claim 1, wherein the acknowledgement signal is an
2 audible signal generated by the computer and sent over the first communications
3 link to the user of the remote unit.

1 8. The system of Claim 1, wherein the computer further comprises
2 means for detecting and correcting errors in the error corrected message signals.

1 9. The system of Claim 8, wherein the means for detecting and
2 correcting errors comprises sending data packets from the remote unit to the
3 computer, the data packets each comprising a plurality of bits; checking the data
4 packets for errors in the computer; communicating to the user of the remote unit
5 from the computer to resend all data packets when errors are present in any data
6 packet; comparing the first-sent data packets to corresponding ones of the resent
7 data packets to determine the presence of errors; and comparing corresponding
8 bits of each first-sent data packet and each resent data packet to select a bit value
9 that is present in a more than half of the data packets.

1 10. A method for communicating data between a computer and a unit
2 remote from the computer, comprising:
3 receiving input information from a user to the remote unit;
4 generating data signals in the remote unit corresponding to the input
5 information;
6 producing error corrected message signals in the remote unit corresponding
7 to the data signals;
8 generating acoustical tones in the remote unit corresponding to the error
9 corrected message signals;
10 transmitting the acoustical tones to the computer by coupling the acoustical
11 tones to a send-only first communications link between the computer and the
12 remote unit; and
13 receiving, in a receiving unit of the remote unit, data from the computer over
14 a receive-only second communications link, which is independent of the first
15 communications link.

1 11. The method of Claim 10, further comprising receiving, in a second
2 receiving unit of the remote unit, a signal over the first communications link from
3 the computer acknowledging receipt of the acoustical tones.

1 12. The method of Claim 10, wherein producing error corrected message
2 signals comprises generating forward error corrected data by encoding the data
3 signals.

1 13. The method of Claim 10, wherein coupling the acoustical tones to the
2 first communications link comprises generating the acoustical tones over a speaker
3 on the remote unit that is held near an input device attached to the first
4 communications link.

1 14. The method of Claim 10, wherein receiving the acknowledgement
2 signal comprises receiving a message indicating that the data transmission is
3 successful.

1 15. The method of Claim 10, wherein receiving the acknowledgement
2 signal comprises receiving a request to resend the data.

1 16. The method of Claim 10, further comprising detecting and correcting
2 errors in the error corrected message signals from the remote unit.

1 17. The method of Claim 16, wherein the detecting and correcting errors
2 comprises sending data packets from the remote unit to the computer, the data
3 packets each comprising a plurality of bits; checking the data packets for errors in
4 the computer; communicating to the user of the remote unit from the computer to
5 resend all data packets when errors are present in any data packet; comparing the
6 first-sent data packets to the corresponding resent data packets to determine the
7 presence of errors; and comparing corresponding bits of each first-sent data
8 packet and each resent data packet to select a bit value that is present in a more
9 than half of the data packets.

1 18. A method for communicating data between a computer and a unit
2 remote from the computer, comprising:
3 sending data packets from the remote unit to the computer, the data

4 packets each comprising a plurality of bits;
5 checking the data packets for errors in the computer;
6 communicating to the user of the remote unit from the computer to resend
7 all data packets when errors are present in any data packet;
8 comparing the first-sent data packets to corresponding ones of the resent
9 data packets to determine the presence of errors; and
10 comparing corresponding bits of each first-sent data packet and each resent
11 data packet to select a bit value that is present in a more than half of the data
12 packets.

1 19. The method of Claim 18, wherein checking the data packets
2 comprises generating an integrity flag, for the data packets, that indicates errors
3 within the data packets, wherein a good integrity flag indicates no errors, and a
4 bad integrity flag indicates errors, and checking the integrity flags of the data
5 packets.

1 20. The method of Claim 18, wherein the communicating from the
2 computer to the remote unit further comprises sending a signal from the computer
3 back to the user of the remote unit indicating a successful transmission.

1 21. The method of Claim 19, wherein comparing the data packets
2 comprises comparing the integrity flags of the data packets to each other.

1 22. For use in a system for communicating data between a computer and
2 a unit remote to the computer, the remote unit comprising means for receiving
3 input information from a user and for producing data signals corresponding to the
4 input information; means for producing error corrected message signals from the
5 data signals; means for generating acoustical tones corresponding to the error
6 corrected message signals; means for coupling the acoustical tones to a send-only
7 first communications link for transmission to the computer; first receiving means for
8 receiving a signal, over the first communications link, from the computer to the user
9 of the remote unit to acknowledge receipt of the acoustical tones; and a second
10 receiving means for receiving data from the computer over a send-only second

11 communications link, which is independent of the first communications link.

SUBSTITUTE SHEET (RULE 26)

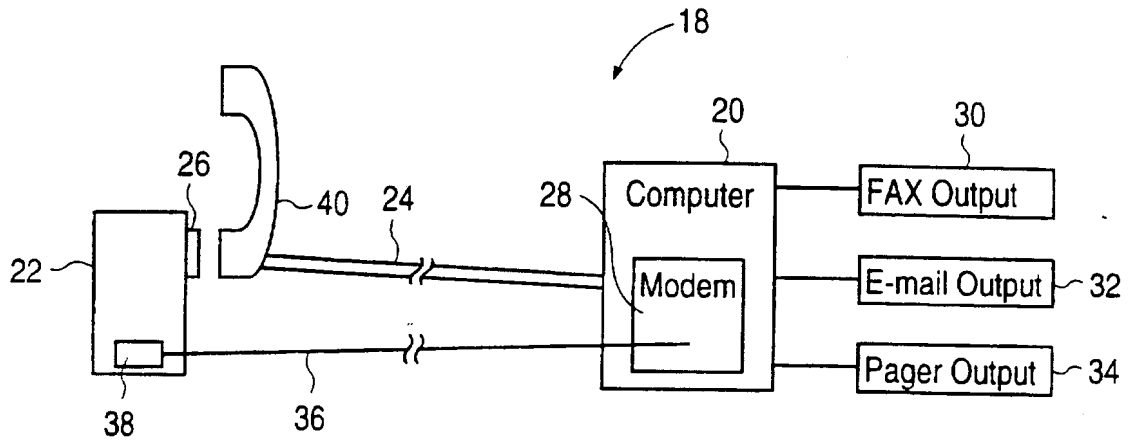

FIG. 1

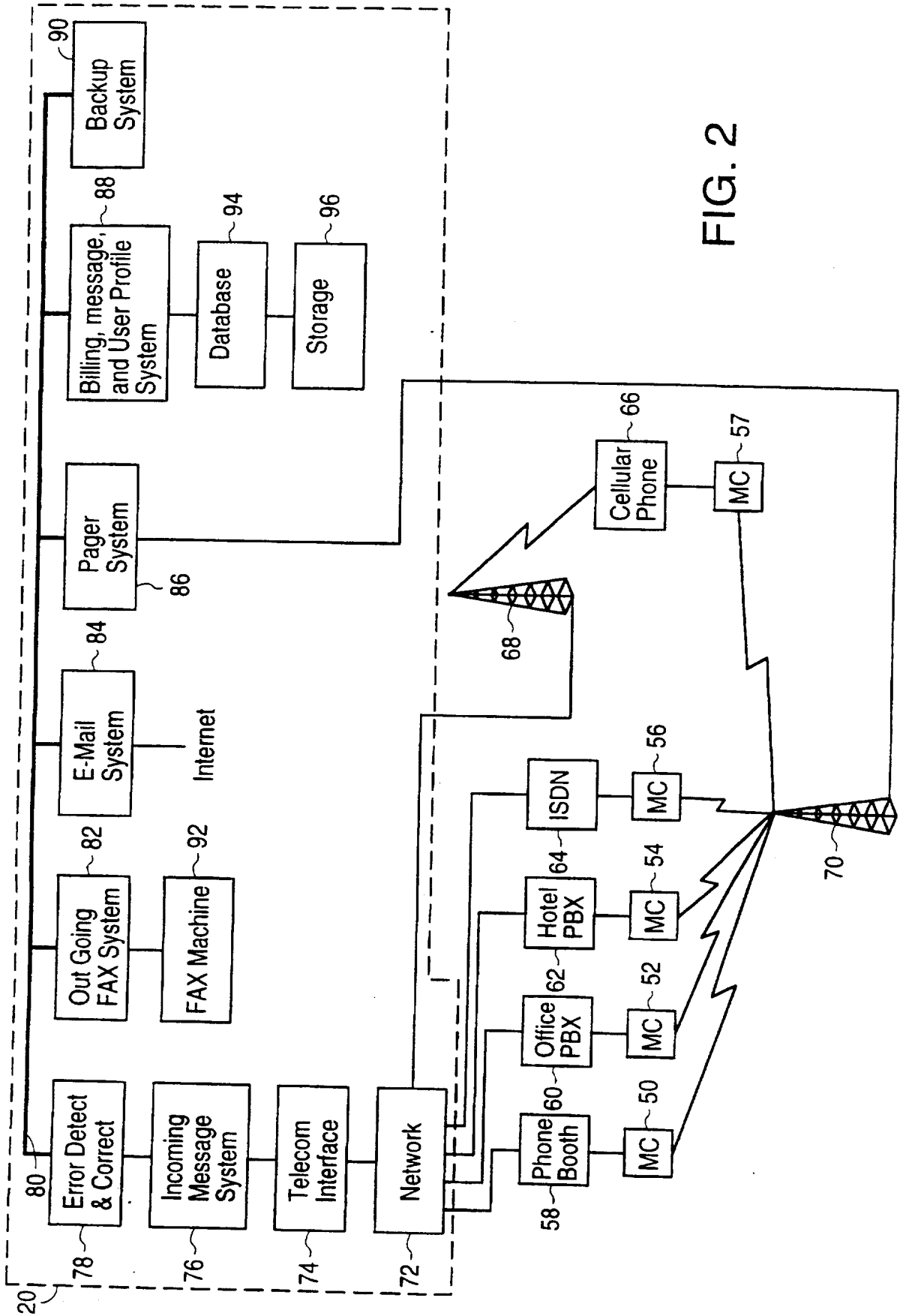

FIG. 2

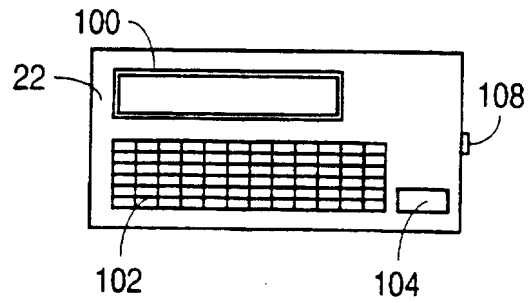

FIG. 3

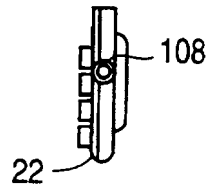

FIG. 4

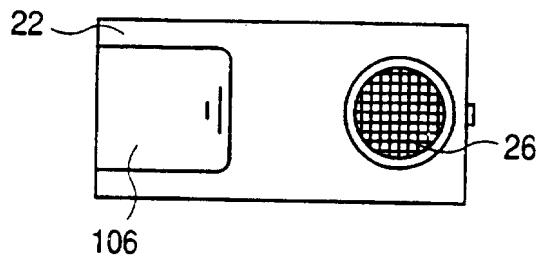

FIG. 5

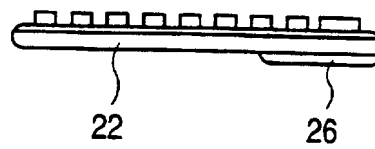

FIG. 6

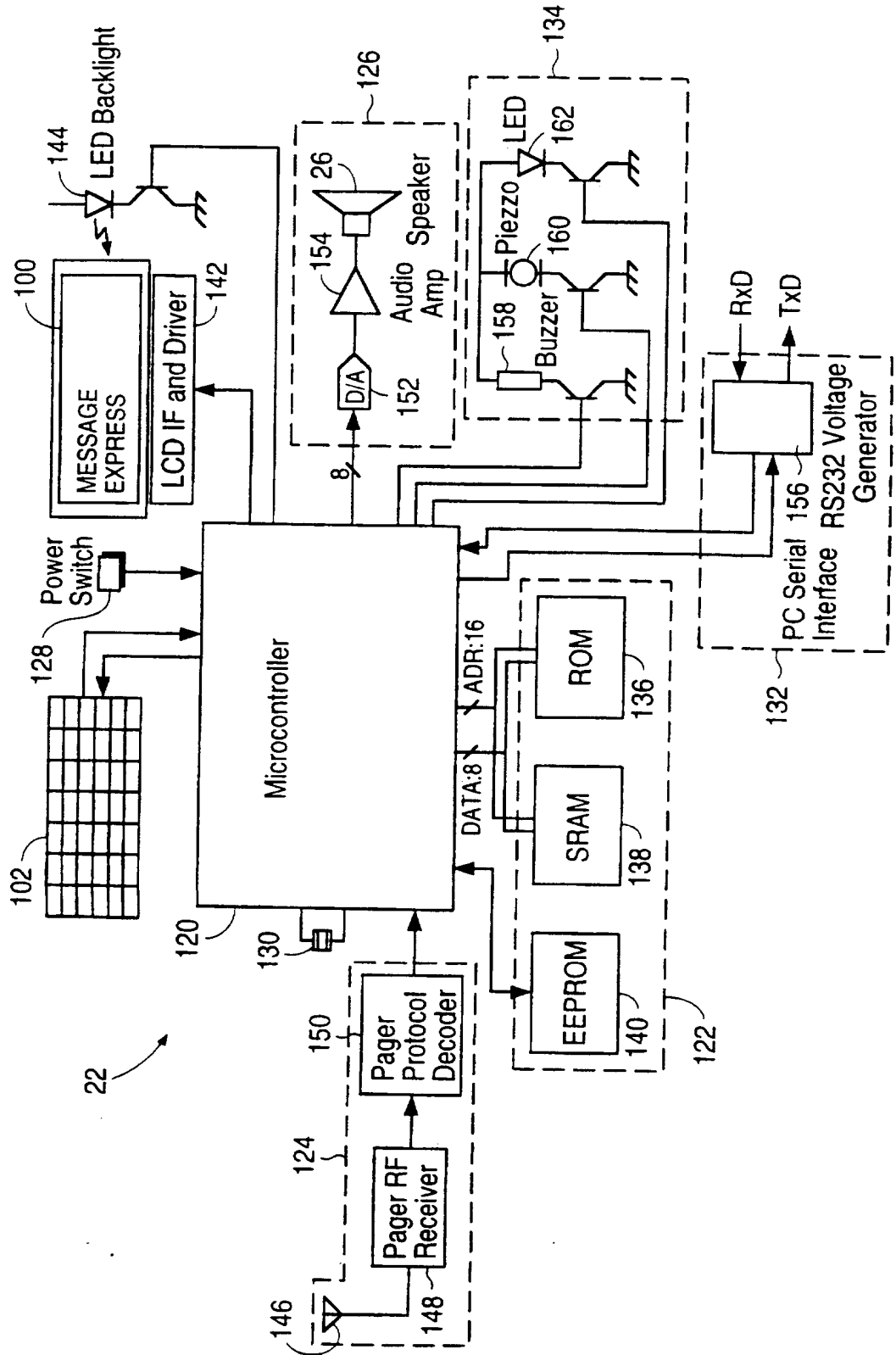

FIG. 7

5/12

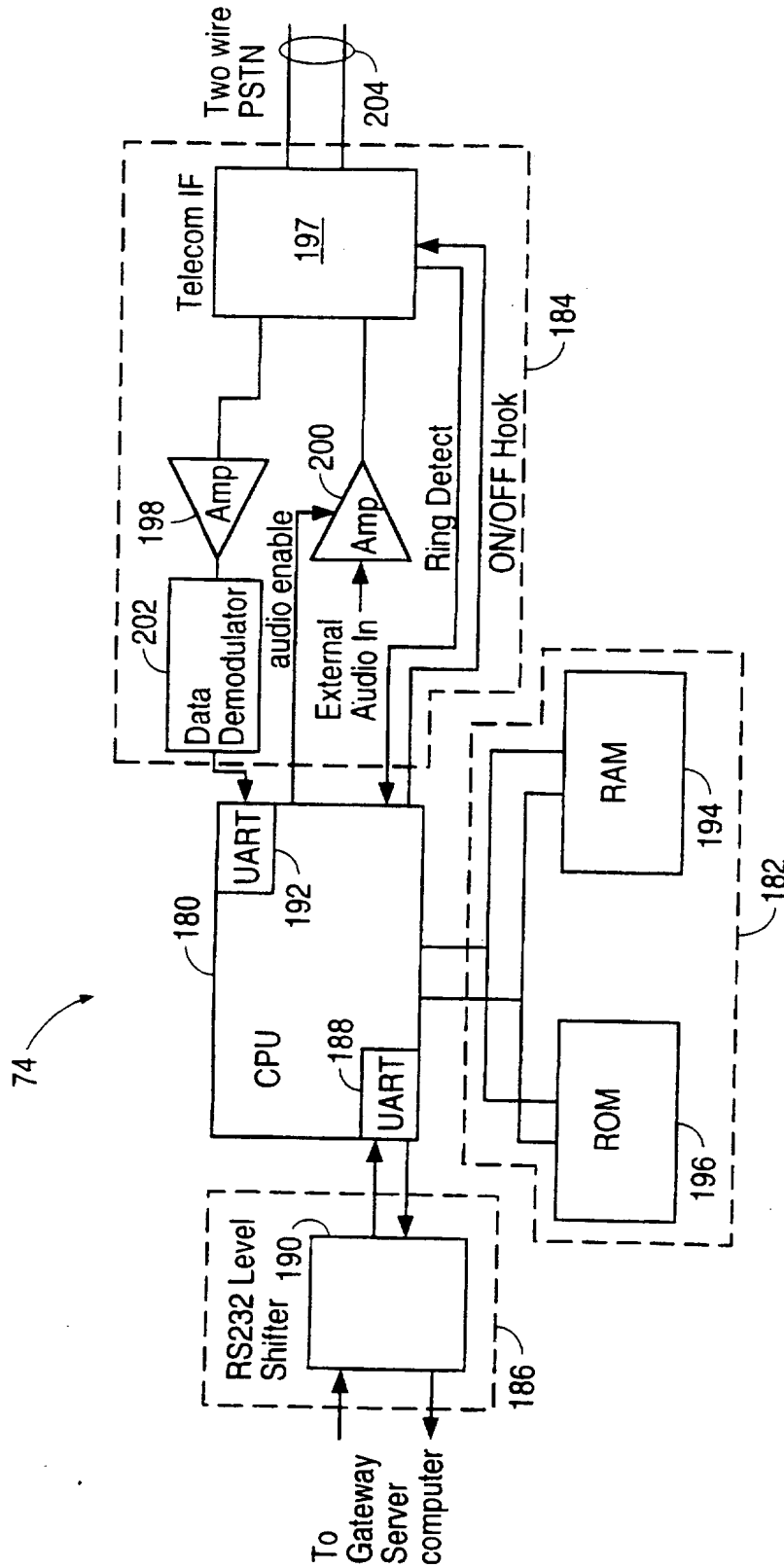

FIG. 8

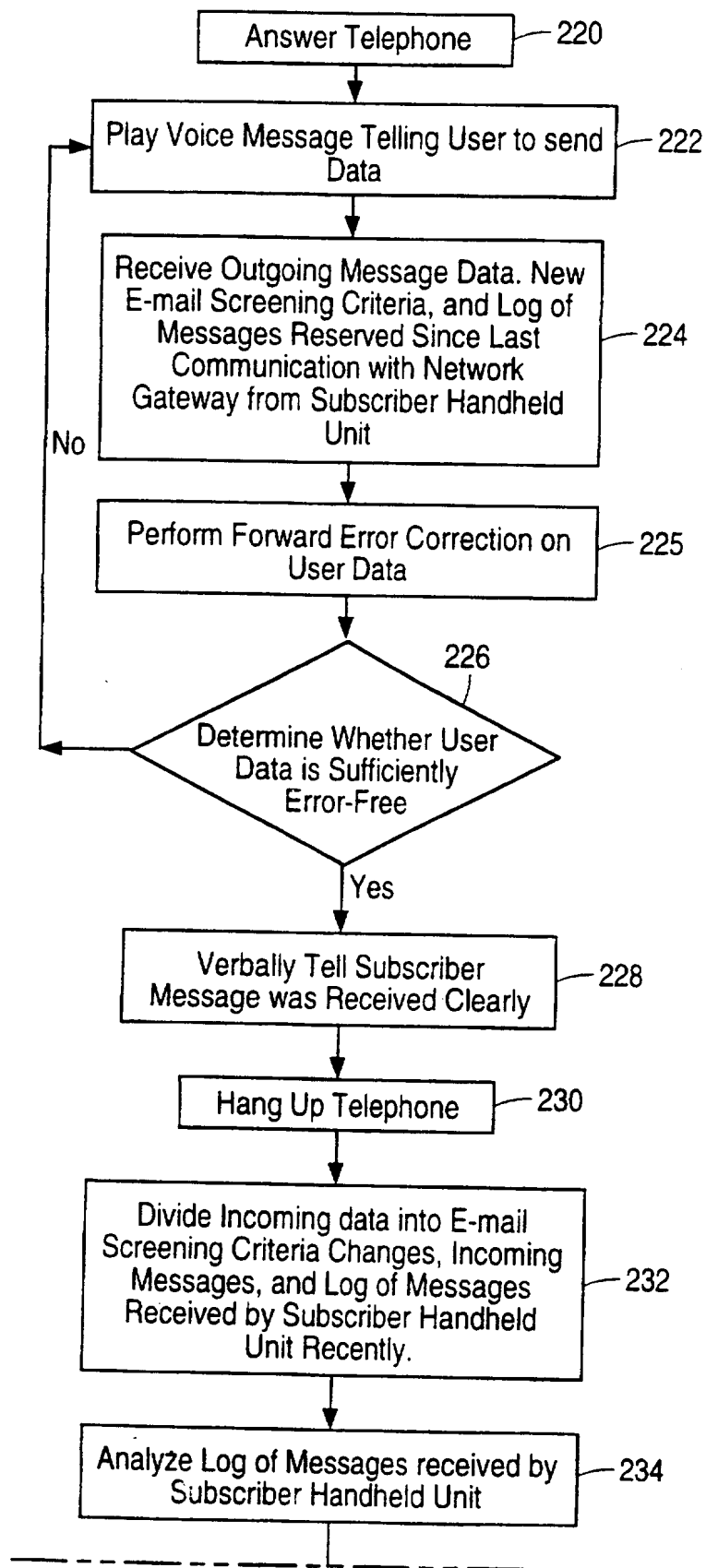

FIG. 9A

7/12

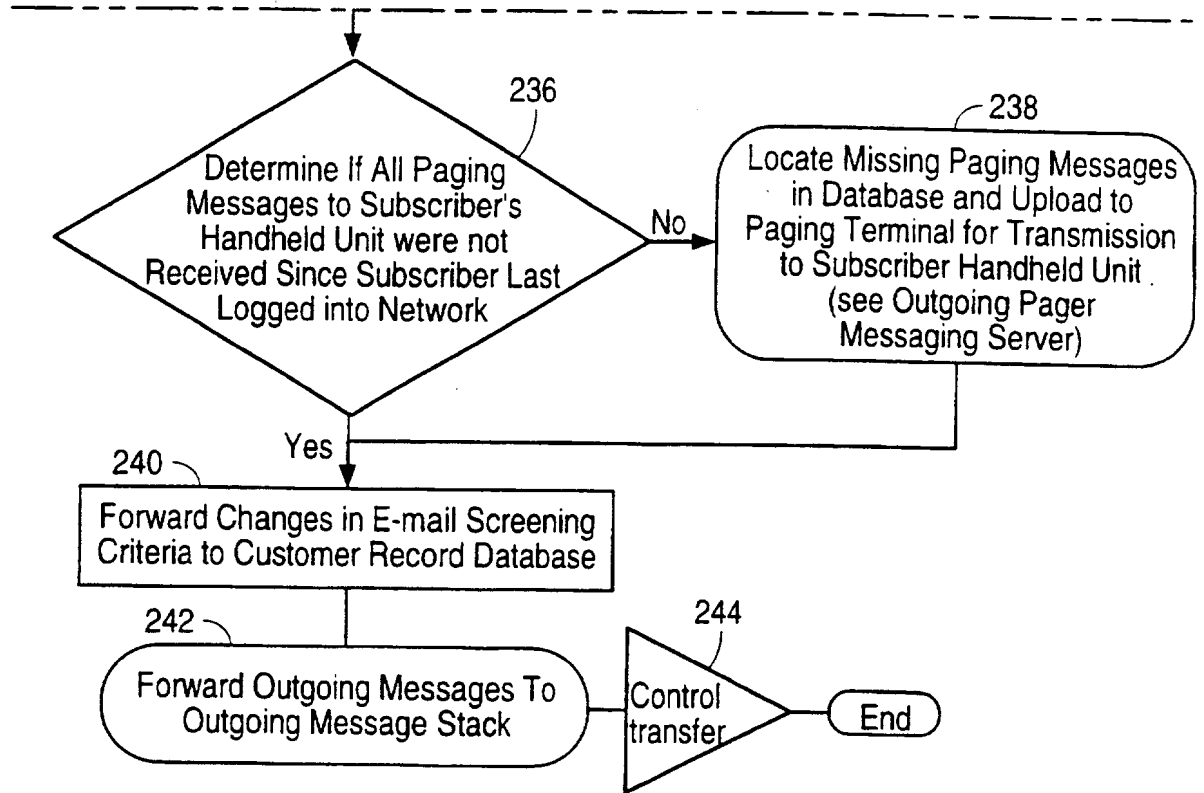

FIG. 9B

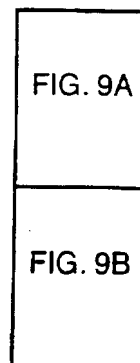

FIG. 9

8/12

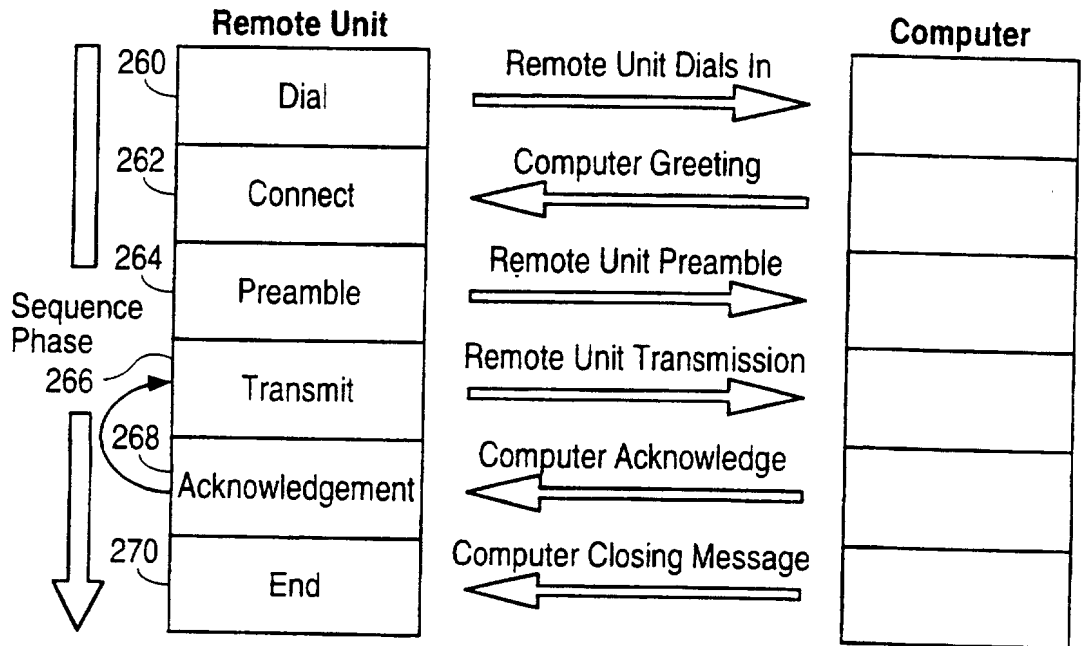

FIG. 10

9/12

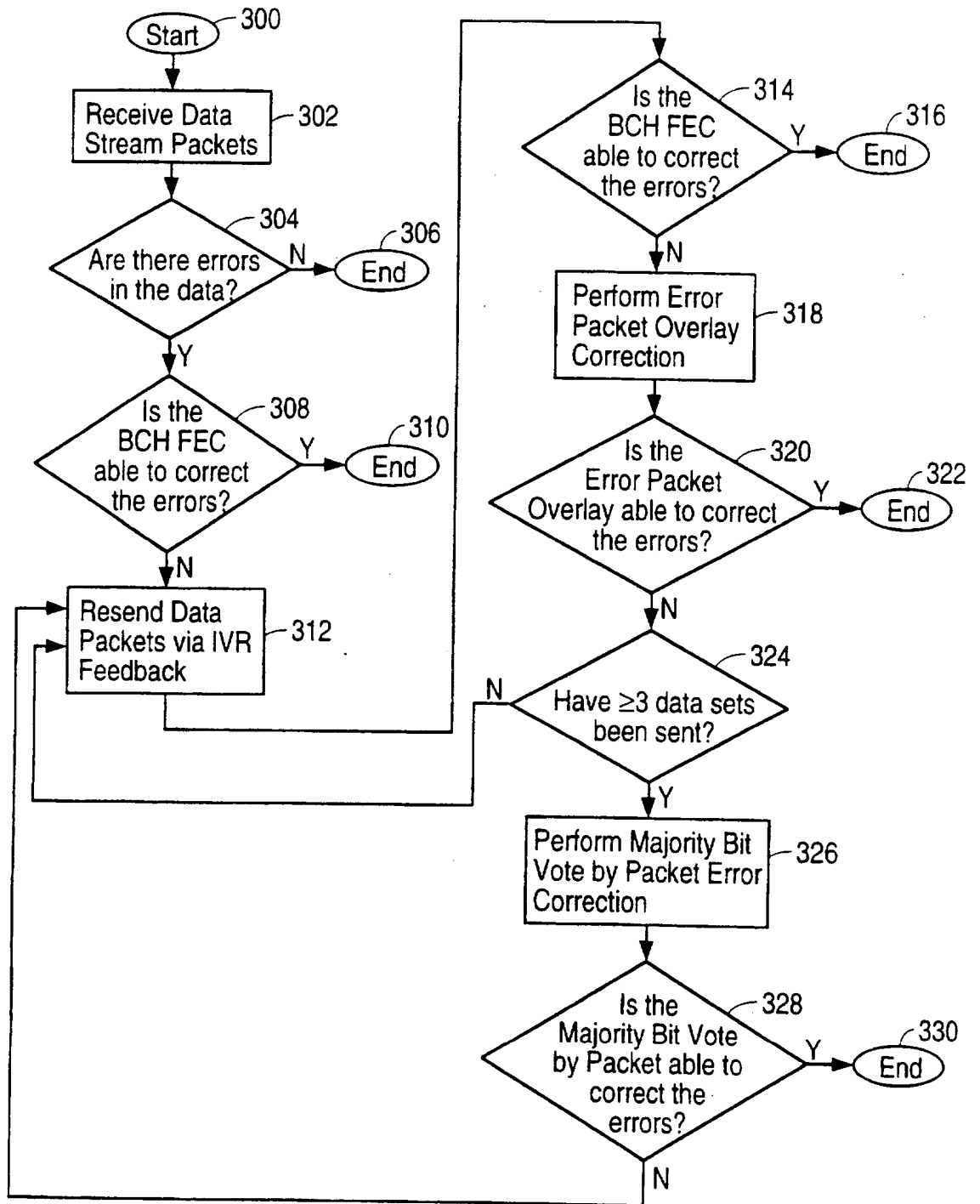

FIG. 11

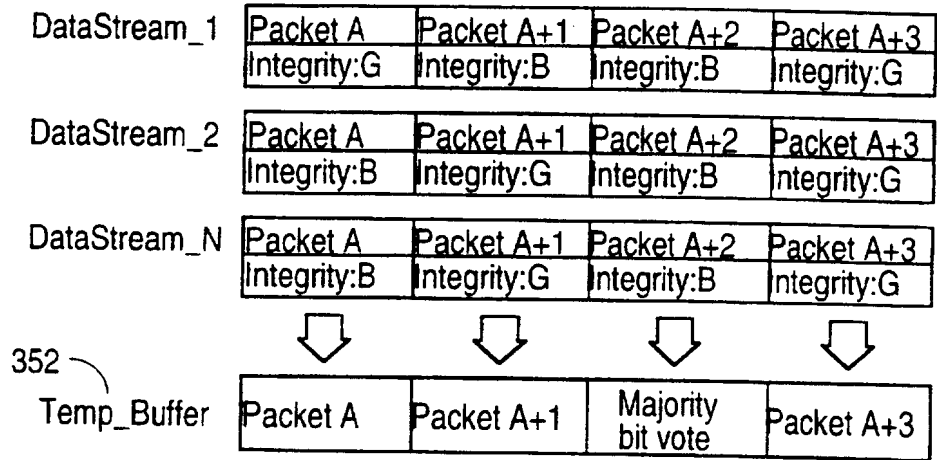

FIG. 12

11/12

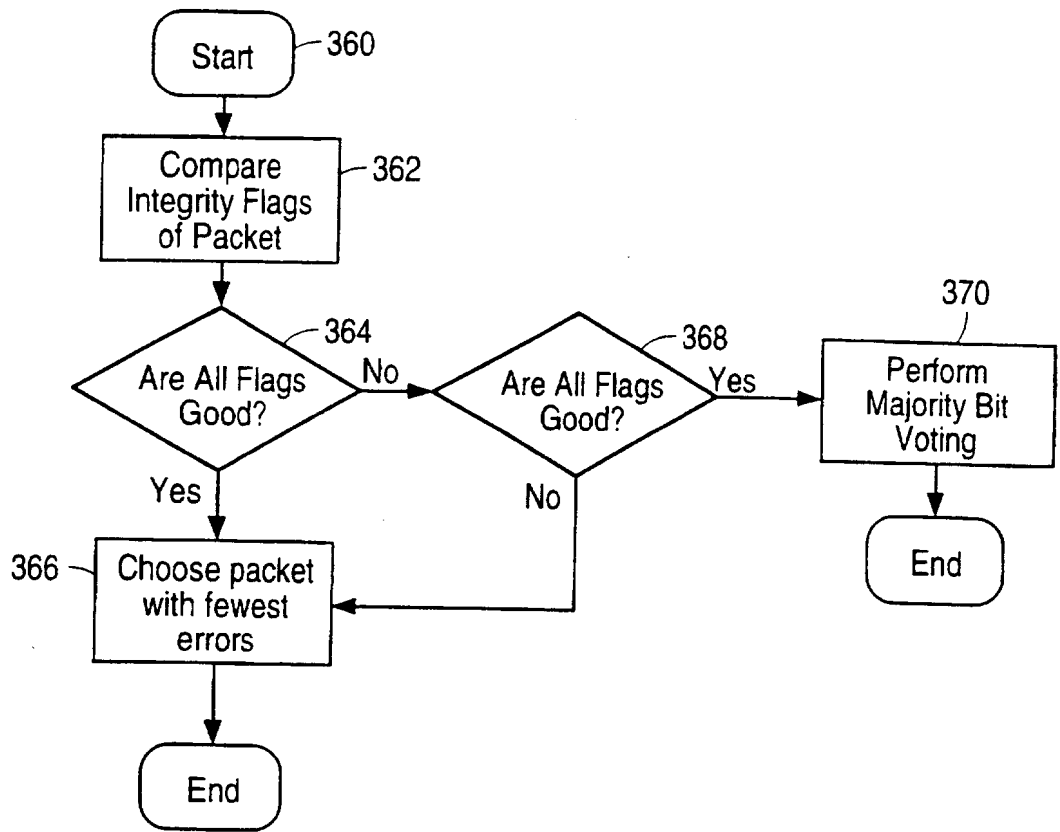

FIG. 13

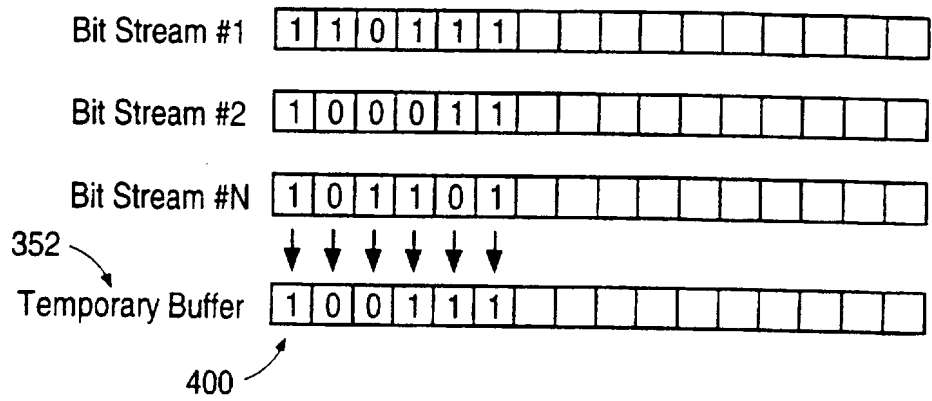

FIG. 14

INTERNATIONAL SEARCH REPORT

International application No
PCT/US97/00823

A. CLASSIFICATION OF SUBJECT MATTER
 IPC(6) :H03M 13/00; H04L 1/18; H04M 11/00
 US CL :371/33, 35, 62; 379/58, 100
 According to International Patent Classification (IPC) or to both national classification and IPC

B. FIELDS SEARCHED
 Minimum documentation searched (classification system followed by classification symbols)
 U.S. : 371/33, 35, 62; 379/56, 57, 58, 100; 358/405, 406, 440, 442, 468; 370/448, 479, 375/206 ; 455/53.1, 54.1, 89

Documentation searched other than minimum documentation to the extent that such documents are included in the fields searched

Electronic data base consulted during the international search (name of data base and, where practicable, search terms used)
 MAYA

C. DOCUMENTS CONSIDERED TO BE RELEVANT

Category*	Citation of document, with indication, where appropriate, of the relevant passages	Relevant to claim No.
Y, P	US 5,588,009 A (WILL) 24 December 1996, column 5, lines 8-34.	1-22
Y, P	US 5,509,050 A (BERLAND) 16 April 1996, column 6, lines 30-52.	1-22
A	US 5,142,550 A (TYMES) 25 August 1992, see abstract.	1-22
A	US 4,584,679 A (LIVINGSTON ET AL.) 22 April 1986, column 2, lines 47-62.	1-22

Further documents are listed in the continuation of Box C. See patent family annex.

- * Special categories of cited documents:
- *A* document defining the general state of the art which is not considered to be of particular relevance
- *E* earlier document published on or after the international filing date
- *L* document which may throw doubt on priority claim(s) or which is cited to establish the publication date of another citation or other special reason (as specified)
- *O* document referring to an oral disclosure, use, exhibition or other means
- *P* document published prior to the international filing date but later than the priority date claimed
- *T* later document published after the international filing date or priority date and not in conflict with the application but cited to understand the principle or theory underlying the invention
- *X* document of particular relevance; the claimed invention cannot be considered novel or cannot be considered to involve an inventive step when the document is taken alone
- *Y* document of particular relevance; the claimed invention cannot be considered to involve an inventive step when the document is combined with one or more other such documents, such combination being obvious to a person skilled in the art
- *A* document member of the same patent family

Date of the actual completion of the international search
26 MARCH 1997

Date of mailing of the international search report
23 APR 1997

Name and mailing address of the ISA/US
 Commissioner of Patents and Trademarks
 Box PCT
 Washington, D.C. 20231
 Facsimile No. (703) 305-3230

Authorized officer
 EMMANUEL L. MOISE *Jon Hill*
 Telephone No. (703) 305-9706